

Article number: 51835143080010

Description: Vibration damper VIBR M0025

Measures

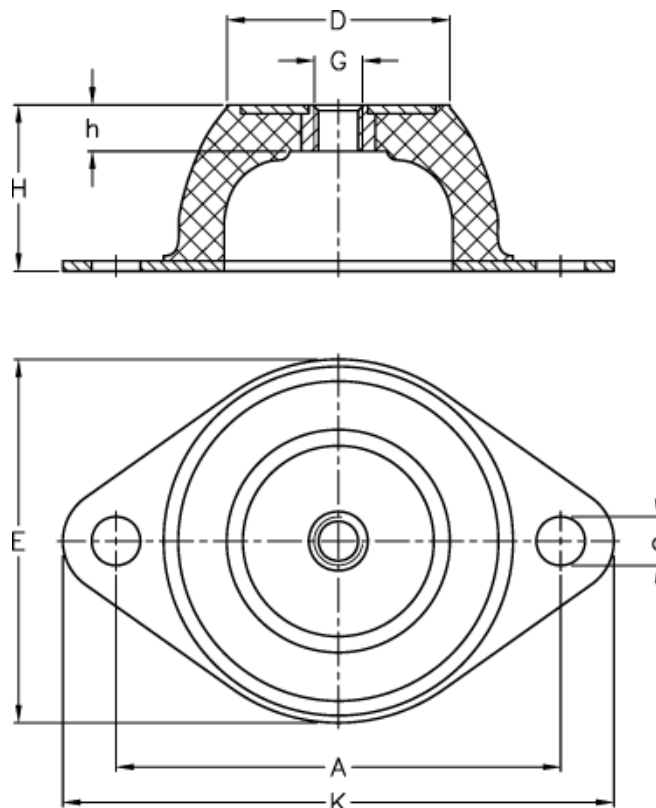

A = 66 Max. (kg) 40 degrees C = 20.0

D = 33 Max. (kg) 60 degrees C = 50

d = 8.0

E = 56

G = M8

H = 25

h = 11

K = 85